

DC Axial Fan 35x35x10mm

■ 尺寸图 (DIMENSION DRAWING)

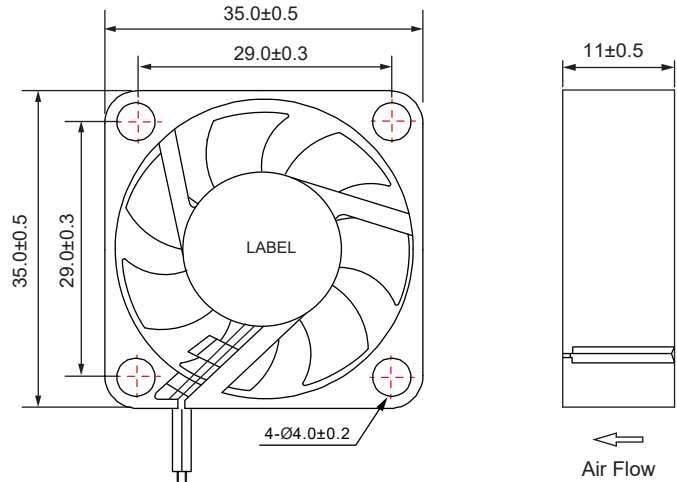
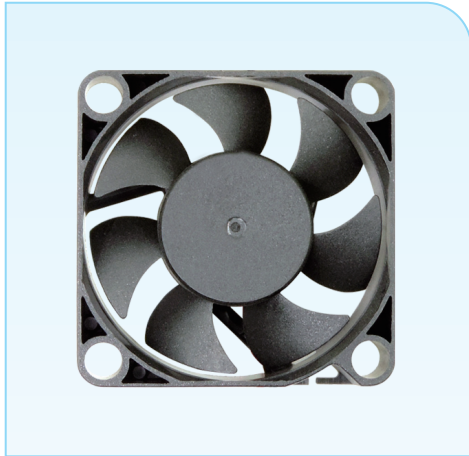

- * 轴承类型: 含油轴承, 双滚珠轴承, 液压轴承
(Bearing type: Sleeve, 2-Ball, Hydraulic)
- * 材料(Material):
框叶(Frame & Impeller): PBT
- * 引线(Lead wire):
UL1571 AWG #28 or equivalent
红色线正级 Red Wire Positive (+)
黑色线负级 Black Wire Negative (-)
- * 可选择增加风扇功能(Functions are optional)
- * 重量(Weight): 9.0g

■ 风压&风量曲线图 P and Q CURVE

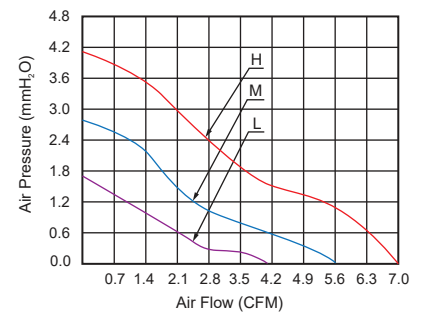

型号 Model	轴承类型 Bearing Type	电压 Rated Voltage	电压范围 Operation Voltage	电流 Current	功率 Input Power	转速 Speed	风量 Air Flow	风压 Static Pressure	噪音 Noise Level
		VDC	VDC	Amp	Watt	RPM	CFM	MM-H ₂ O	dBA
CC3510L05S	Sleeve	5V	4.5~5.5	0.05	0.25	5,000±10%	4.00	1.70	21.0
CC3510L05D	2-Ball								
CC3510L05SH	Hydraulic								
CC3510M05S	Sleeve	5V	4.5~5.5	0.09	0.45	7,000±10%	5.60	2.80	26.0
CC3510M05D	2-Ball								
CC3510M05SH	Hydraulic								
CC3510H05S	Sleeve	5V	4.5~5.5	0.26	1.30	9,000±10%	7.00	4.10	33.0
CC3510H05D	2-Ball								
CC3510H05SH	Hydraulic								
CC3510L12S	Sleeve	12V	10.8~13.2	0.02	0.24	5,000±10%	4.00	1.70	21.0
CC3510L12D	2-Ball								
CC3510L12SH	Hydraulic								
CC3510M12S	Sleeve	12V	10.8~13.2	0.10	1.20	7,000±10%	5.60	2.80	26.0
CC3510M12D	2-Ball								
CC3510M12SH	Hydraulic								
CC3510H12S	Sleeve	12V	10.8~13.2	0.12	1.44	9,000±10%	7.00	4.10	33.0
CC3510H12D	2-Ball								
CC3510H12SH	Hydraulic								

- * 以上为额定电压下的常规参数(All readings are typical values at rated voltage)
- * 规格如有变动不另行通知(Specifications are subjected to change without prior notice)